

INDOOR VOLTAGE TRANSFORMER

Models **PT3-1-45**
PT3-2-45

ACCURACY CLASS:
0.3 WX, 0.6MY, 1.2Z at 100% rated voltage with 120V based ANSI burden.
0.6 WX, 1.2MY at 58% rated voltage with 69.3V based ANSI burden.

FREQUENCY:
60 Hz.

MAXIMUM SYSTEM VOLTAGE:
5.6kV, BIL 45kV full wave.

THERMAL RATING:
600 VA at 30°C. amb.
400 VA at 55°C. amb.

WEIGHT:
Approximately 20 lbs., unfused.

REGULATORY AGENCY APPROVALS



Manufactured to meet the requirements of ANSI/IEEE C57.13.
Classified by U.L. in accordance with IEC 44-2

- Primary terminals that are unfused are No.10-32 brass screws with one flatwasher and lockwasher.
- Primary terminals that are fused are No.10-32 brass screws with one flatwasher and lockwasher and two nuts.
- Secondary terminals are No.10-32 screws, with one lockwasher and flatwasher.
- The core and coil assembly is encased in a plastic enclosure and vacuum encapsulated in polyurethane resin.
- The transformers are tested for partial discharge to Canadian Standards CAN 3-C13-M83. This test can also be carried out to IEC requirements if requested.
- Plated steel mounting base.
- Fuses have 1" Dia Caps and 5" clip centers. 0.81" Dia clips are available.
- Switchgear style is similar to fused style. No fuse or fuse clips are provided, but inserts for fuse clips are supplied.

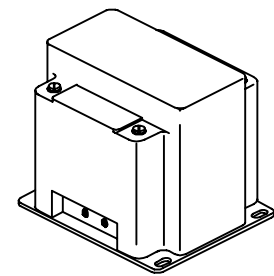
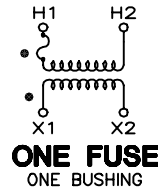
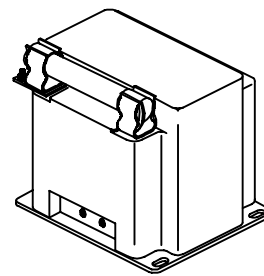
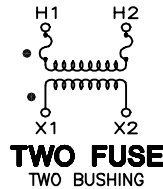
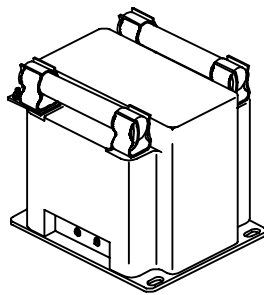
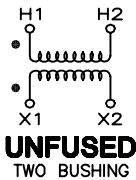
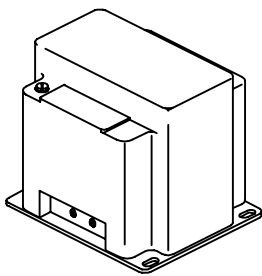

SWITCHGEAR STYLE
TWO BUSHING

TWO BUSHING (a)				CATALOG NUMBERS			
GROUP	PRIMARY VOLTAGE	RATIO	SECONDARY VOLTAGE	UNFUSED	FUSES	FUSE CLIPS ONLY (d)	SWITCHGEAR STYLE
1	840	7:1	120	PT3-2-45-841	PT3-2-45-841FF	PT3-2-45-841CC	PT3-2-45-841SS
1	1200	10:1	120	PT3-2-45-122	PT3-2-45-122FF	PT3-2-45-122CC	PT3-2-45-122SS
1	2400	20:1	120	PT3-2-45-242	PT3-2-45-242FF	PT3-2-45-242CC	PT3-2-45-242SS
2	3300	30:1	110-50Hz	PT3-2-45-332	PT3-2-45-332FF	PT3-2-45-332CC	PT3-2-45-332SS
2	4200	35:1	120	PT3-2-45-422	PT3-2-45-422FF	PT3-2-45-422CC	PT3-2-45-422SS
2	4800	40:1	120	PT3-2-45-482	PT3-2-45-482FF	PT3-2-45-482CC	PT3-2-45-482SS

ONE BUSHING (b)				R _{FR} (c)	CATALOG NUMBERS		
GROUP	PRIMARY VOLTAGE	RATIO	SECONDARY VOLTAGE		FUSES	FUSE CLIPS ONLY (d)	SWITCHGEAR STYLE
4A	2400	20:1	120	190	PT3-1-45-242F	PT3-1-45-242C	PT3-1-45-242S
4B	4200	35:1	120	190	PT3-1-45-422F	PT3-1-45-422C	PT3-1-45-422S
4B	4800	40:1	120	190	PT3-1-45-482F	PT3-1-45-482C	PT3-1-45-482S

(a) Two fuse transformers should not be used for Y connections. It is preferred practice to connect one lead from each voltage transformer directly to the neutral terminal, using a fuse in the line side of the primary only. By using this connection a transformer can never be made "live" from the line side by reason of a blown fuse in the neutral side. For continuous operation the transformer primary voltage should not exceed 110% of rated value.

(b) Voltage transformers connected line-to-ground cannot be considered to be grounding transformers and must not be operated with the secondaries in closed delta because excessive currents may flow in the delta.

(c) See page 4, item 2 for ferroresonance considerations. Values in table are in ohms.

NOTE: It is recommended the system line-to-line voltage not exceed the transformer maximum system voltage level.

(d) Fuse clips with suffix "CC" or "C" accept fuses with 1.0 in. dia. caps and 5 in. clip centers. Fuse clips with suffix "CCS" or "CS" accept fuses with 0.81 in. dia. caps and 5 in. clip centers.

PT3-1-45 PT3-2-45

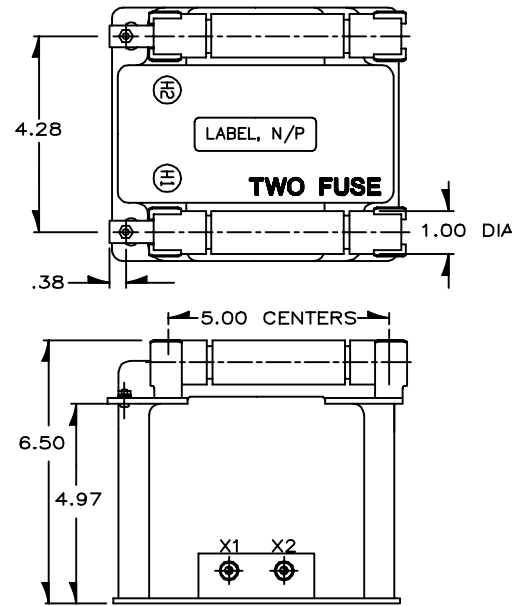
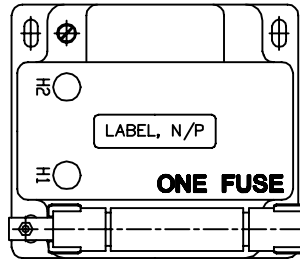
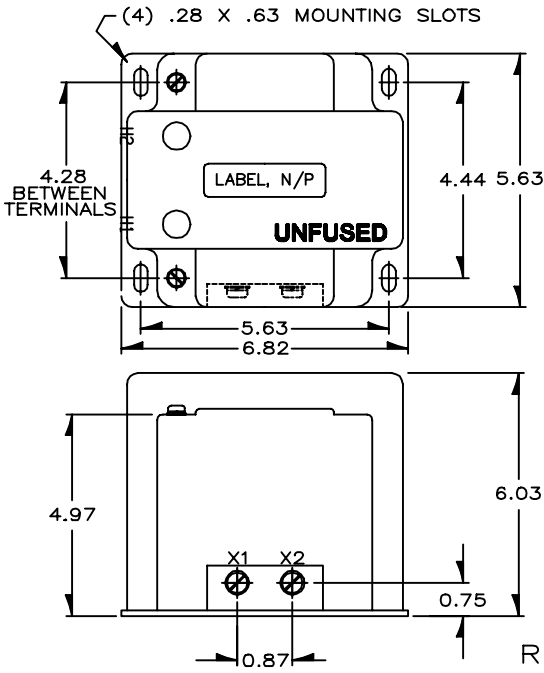

RECOMMENDED SPACINGS

A=UNIT TO UNIT =0.75" MIN.
B=HV TO GROUND IN AIR=3.0" MIN.

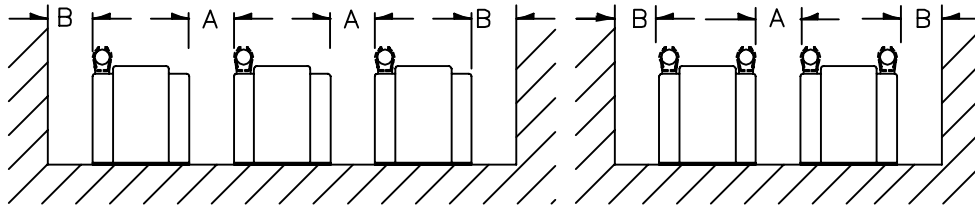

Recommended spacings are for guidance only. User needs to set appropriate values to assure performance for: high potential test; impulse test; high humidity; partial discharge; high altitude; and other considerations like configuration.

FUSE FOR MODEL PT3 TRANSFORMER	RATING VOLTS	INTERRUPTING AMPERES(SYM)	SUGGESTED RATING * CONTINUOUS AMPERES	CAP DIA. INCHES	LENGTH INCHES	CLIP CENTERS INCHES
2400:120V	5.5kV	45,000	2.0E	1.0	5.63	5.00
3300:110V	5.5kV	45,000	2.0E	1.0	5.63	5.00
4200:120V	5.5kV	45,000	1.0E	1.0	5.63	5.00
4800:120V	5.5kV	45,000	1.0E	1.0	5.63	5.00

* SEE PAGE 4, Primary Fuse Rating.

CIRCLE DIAGRAM

The circle diagram can be used to predict the performance of a transformer for various loads and power factors. A convenient scale of volt-amperes is shown on the unity power factor line (u.p.f.) and commences at the zero or no-load locus. To use the diagram, measure the known V.A. and scribe an arc about the "zero" locus of a length that contains the angle of the burden power factor. The point at which the arc terminates is the error locus in phase angle minutes and ratio correction factor.

